

# 2N5401

## Amplifier Transistors

### PNP Silicon

#### Features

- These are Pb-Free Devices\*

#### MAXIMUM RATINGS

Rating	Symbol	Value	Unit
Collector – Emitter Voltage	$V_{CEO}$	150	Vdc
Collector – Base Voltage	$V_{CBO}$	160	Vdc
Emitter – Base Voltage	$V_{EBO}$	5.0	Vdc
Collector Current – Continuous	$I_C$	600	mAdc
Total Device Dissipation @ $T_A = 25^\circ\text{C}$ Derate above $25^\circ\text{C}$	$P_D$	625 5.0	mW mW/ $^\circ\text{C}$
Total Device Dissipation @ $T_C = 25^\circ\text{C}$ Derate above $25^\circ\text{C}$	$P_D$	1.5 12	W mW/ $^\circ\text{C}$
Operating and Storage Junction Temperature Range	$T_J, T_{stg}$	-55 to +150	$^\circ\text{C}$

#### THERMAL CHARACTERISTICS

Characteristic	Symbol	Max	Unit
Thermal Resistance, Junction-to-Ambient	$R_{\theta JA}$	200	$^\circ\text{C}/\text{W}$
Thermal Resistance, Junction-to-Case	$R_{\theta JC}$	83.3	$^\circ\text{C}/\text{W}$

Stresses exceeding Maximum Ratings may damage the device. Maximum Ratings are stress ratings only. Functional operation above the Recommended Operating Conditions is not implied. Extended exposure to stresses above the Recommended Operating Conditions may affect device reliability.

\*For additional information on our Pb-Free strategy and soldering details, please download the ON Semiconductor Soldering and Mounting Techniques Reference Manual, SOLDERRM/D.



**ON Semiconductor®**

<http://onsemi.com>

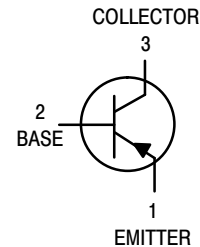

TO-92  
CASE 29  
STYLE 1

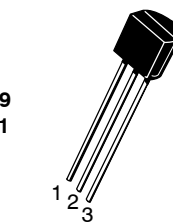

STRAIGHT LEAD  
BULK PACK

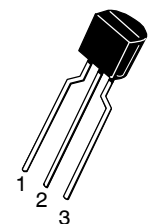

BENT LEAD  
TAPE & REEL  
AMMO PACK

#### MARKING DIAGRAM

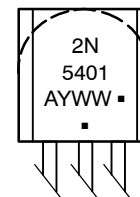

A = Assembly Location  
Y = Year  
WW = Work Week  
▪ = Pb-Free Package

(Note: Microdot may be in either location)

#### ORDERING INFORMATION

See detailed ordering and shipping information in the package dimensions section on page 2 of this data sheet.

## 2N5401

### ELECTRICAL CHARACTERISTICS ( $T_A = 25^\circ\text{C}$ unless otherwise noted)

Characteristic	Symbol	Min	Max	Unit
<b>OFF CHARACTERISTICS</b>				
Collector–Emitter Breakdown Voltage (Note 1) ( $I_C = 1.0\text{ mAdc}$ , $I_B = 0$ )	$V_{(BR)CEO}$	150	–	Vdc
Collector–Base Breakdown Voltage ( $I_C = 100\text{ }\mu\text{Adc}$ , $I_E = 0$ )	$V_{(BR)CBO}$	160	–	Vdc
Emitter–Base Breakdown Voltage ( $I_E = 10\text{ }\mu\text{Adc}$ , $I_C = 0$ )	$V_{(BR)EBO}$	5.0	–	Vdc
Collector Cutoff Current ( $V_{CB} = 120\text{ Vdc}$ , $I_E = 0$ ) ( $V_{CB} = 120\text{ Vdc}$ , $I_E = 0$ , $T_A = 100^\circ\text{C}$ )	$I_{CBO}$	–	50	nAdc $\mu\text{Adc}$
Emitter Cutoff Current ( $V_{EB} = 3.0\text{ Vdc}$ , $I_C = 0$ )	$I_{EBO}$	–	50	nAdc

### ON CHARACTERISTICS (Note 1)

DC Current Gain ( $I_C = 1.0\text{ mAdc}$ , $V_{CE} = 5.0\text{ Vdc}$ ) ( $I_C = 10\text{ mAdc}$ , $V_{CE} = 5.0\text{ Vdc}$ ) ( $I_C = 50\text{ mAdc}$ , $V_{CE} = 5.0\text{ Vdc}$ )	$h_{FE}$	50 60 50	– 240 –	–
Collector–Emitter Saturation Voltage ( $I_C = 10\text{ mAdc}$ , $I_B = 1.0\text{ mAdc}$ ) ( $I_C = 50\text{ mAdc}$ , $I_B = 5.0\text{ mAdc}$ )	$V_{CE(sat)}$	– –	0.2 0.5	Vdc
Base–Emitter Saturation Voltage ( $I_C = 10\text{ mAdc}$ , $I_B = 1.0\text{ mAdc}$ ) ( $I_C = 50\text{ mAdc}$ , $I_B = 5.0\text{ mAdc}$ )	$V_{BE(sat)}$	– –	1.0 1.0	Vdc

### SMALL-SIGNAL CHARACTERISTICS

Current–Gain — Bandwidth Product ( $I_C = 10\text{ mAdc}$ , $V_{CE} = 10\text{ Vdc}$ , $f = 100\text{ MHz}$ )	$f_T$	100	300	MHz
Output Capacitance ( $V_{CB} = 10\text{ Vdc}$ , $I_E = 0$ , $f = 1.0\text{ MHz}$ )	$C_{obo}$	–	6.0	pF
Small–Signal Current Gain ( $I_C = 1.0\text{ mAdc}$ , $V_{CE} = 10\text{ Vdc}$ , $f = 1.0\text{ kHz}$ )	$h_{fe}$	40	200	–
Noise Figure ( $I_C = 250\text{ }\mu\text{Adc}$ , $V_{CE} = 5.0\text{ Vdc}$ , $R_S = 1.0\text{ k}\Omega$ , $f = 1.0\text{ kHz}$ )	NF	–	8.0	dB

1. Pulse Test: Pulse Width  $\leq 300\text{ }\mu\text{s}$ , Duty Cycle  $\leq 2.0\%$ .

### ORDERING INFORMATION

Device	Package	Shipping†
2N5401G	TO–92 (Pb–Free)	5000 Unit / Bulk
2N5401RLRAG	TO–92 (Pb–Free)	2000 / Tape & Reel

†For information on tape and reel specifications, including part orientation and tape sizes, please refer to our Tape and Reel Packaging Specifications Brochure, BRD8011/D.

# 2N5401

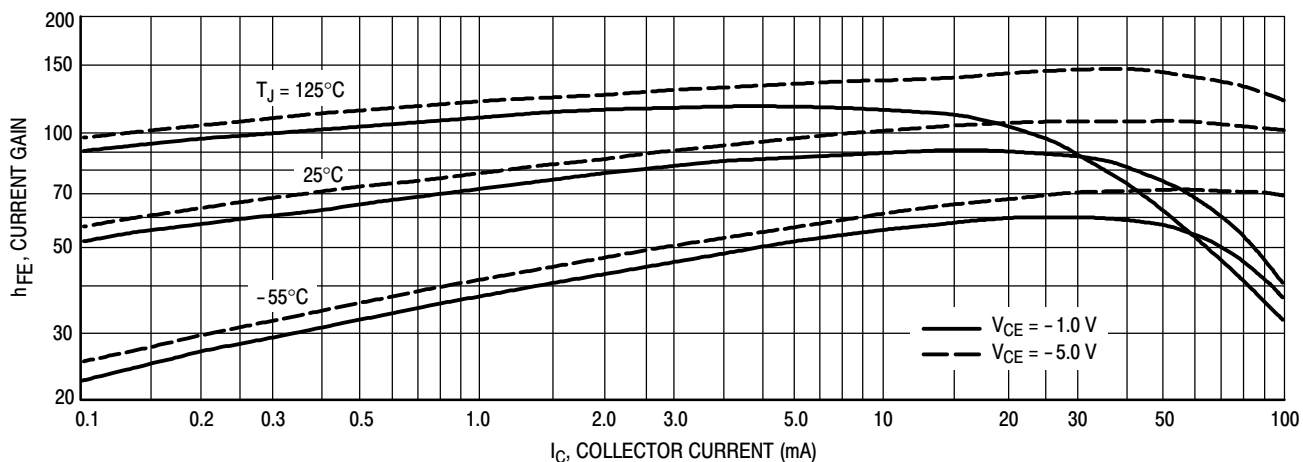

Figure 1. DC Current Gain

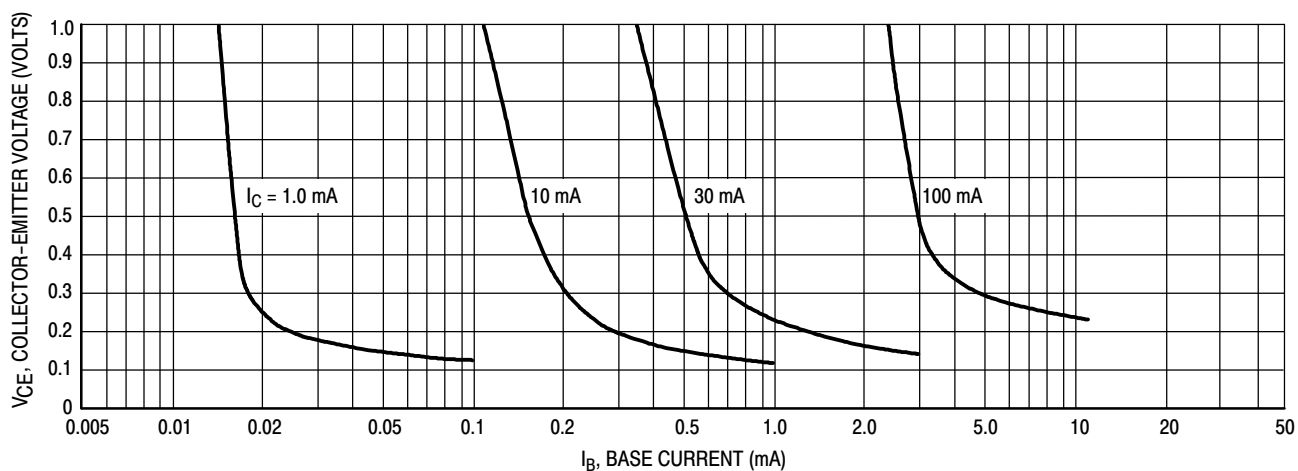

Figure 2. Collector Saturation Region

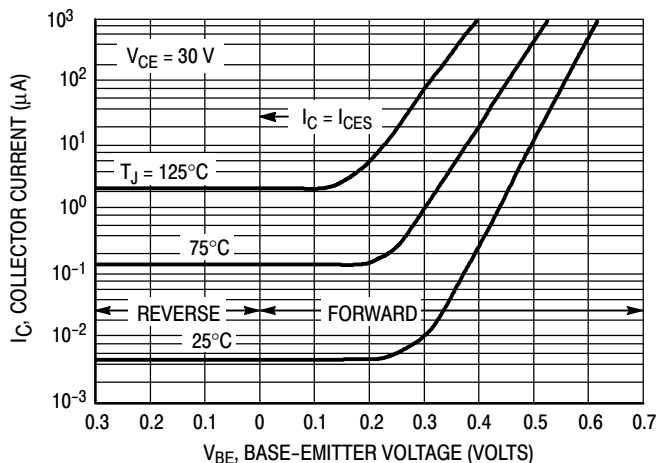

Figure 3. Collector Cut-Off Region

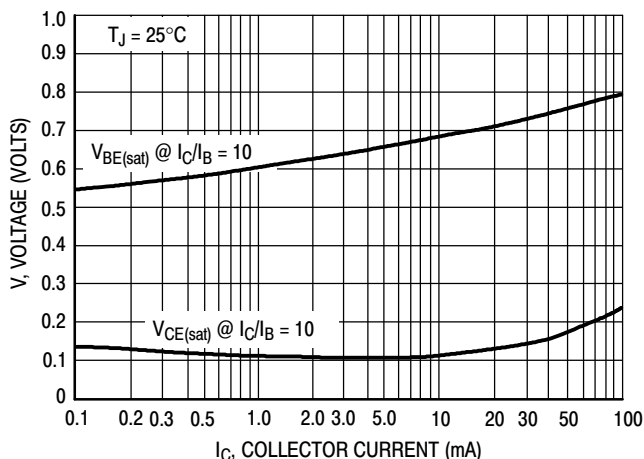

Figure 4. "On" Voltages

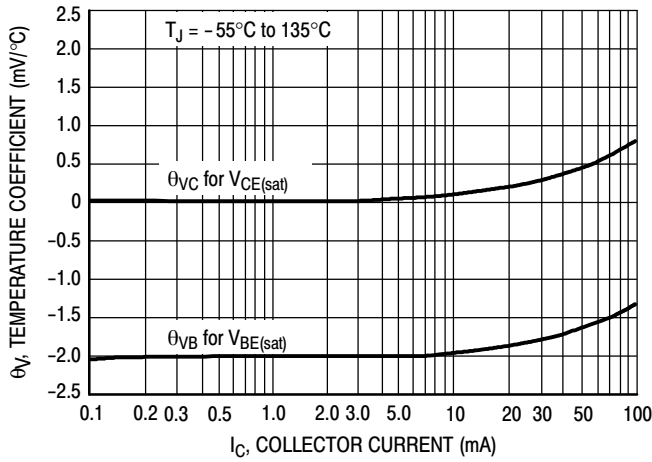
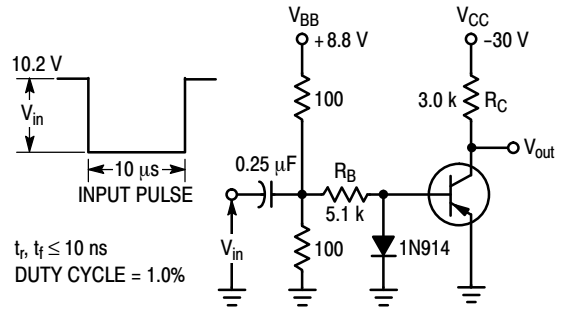

Figure 5. Temperature Coefficients



Values Shown are for  $I_C @ 10 \text{ mA}$

Figure 6. Switching Time Test Circuit

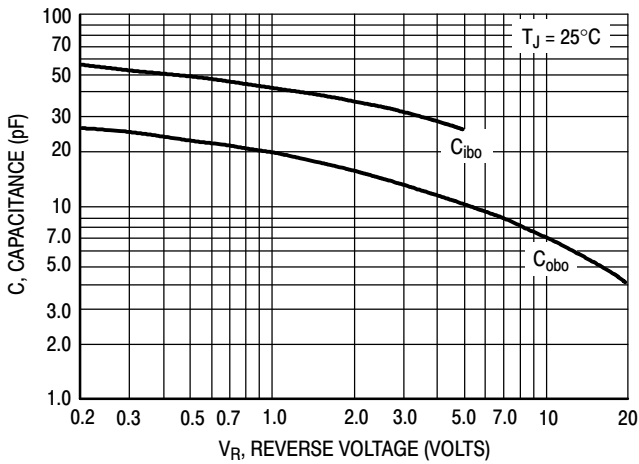

Figure 7. Capacitances

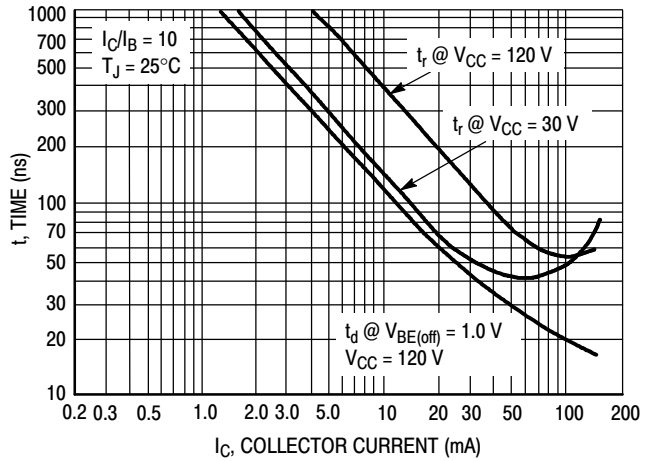

Figure 8. Turn-On Time

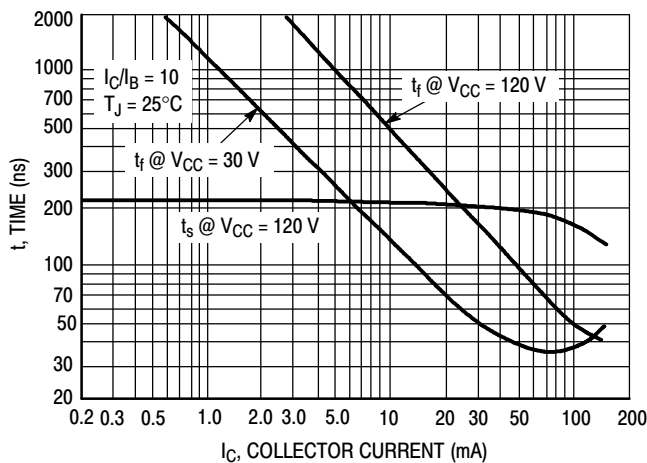

Figure 9. Turn-Off Time

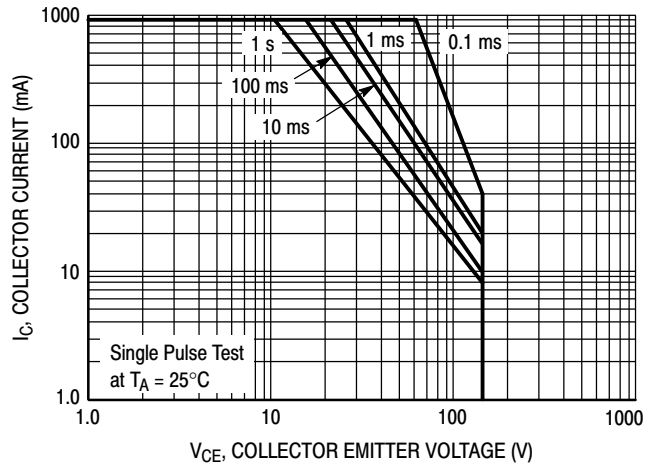
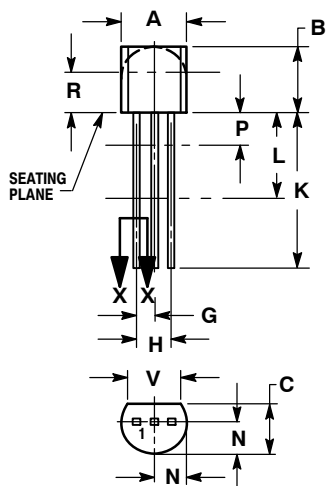

Figure 10. Safe Operating Area

# 2N5401

## PACKAGE DIMENSIONS

TO-92 (TO-226)  
CASE 29-11  
ISSUE AM



STRAIGHT LEAD  
BULK PACK

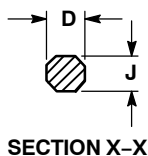

SECTION X-X

NOTES:

1. DIMENSIONING AND TOLERANCING PER ANSI Y14.5M, 1982.
2. CONTROLLING DIMENSION: INCH.
3. CONTOUR OF PACKAGE BEYOND DIMENSION R IS UNCONTROLLED.
4. LEAD DIMENSION IS UNCONTROLLED IN P AND BEYOND DIMENSION K MINIMUM.

DIM	INCHES		MILLIMETERS	
	MIN	MAX	MIN	MAX
A	0.175	0.205	4.45	5.20
B	0.170	0.210	4.32	5.33
C	0.125	0.165	3.18	4.19
D	0.016	0.021	0.407	0.533
G	0.045	0.055	1.15	1.39
H	0.095	0.105	2.42	2.66
J	0.015	0.020	0.39	0.50
K	0.500	---	12.70	---
L	0.250	---	6.35	---
N	0.080	0.105	2.04	2.66
P	---	0.100	---	2.54
R	0.115	---	2.93	---
V	0.135	---	3.43	---

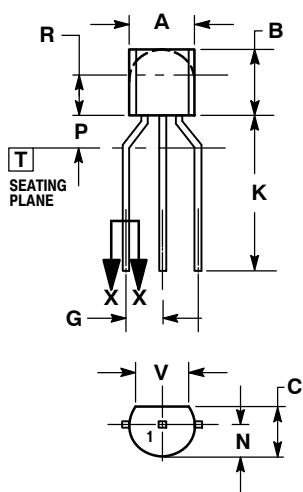

BENT LEAD  
TAPE & REEL  
AMMO PACK

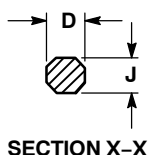

SECTION X-X

NOTES:

1. DIMENSIONING AND TOLERANCING PER ASME Y14.5M, 1994.
2. CONTROLLING DIMENSION: MILLIMETERS.
3. CONTOUR OF PACKAGE BEYOND DIMENSION R IS UNCONTROLLED.
4. LEAD DIMENSION IS UNCONTROLLED IN P AND BEYOND DIMENSION K MINIMUM.

DIM	MILLIMETERS	
	MIN	MAX
A	4.45	5.20
B	4.32	5.33
C	3.18	4.19
D	0.40	0.54
G	2.40	2.80
J	0.39	0.50
K	12.70	---
N	2.04	2.66
P	1.50	4.00
R	2.93	---
V	3.43	---

STYLE 1:

1. EMITTER
2. BASE
3. COLLECTOR

ON Semiconductor and are registered trademarks of Semiconductor Components Industries, LLC (SCILLC). SCILLC owns the rights to a number of patents, trademarks, copyrights, trade secrets, and other intellectual property. A listing of SCILLC's product/patent coverage may be accessed at [www.onsemi.com/site/pdf/Patent-Marking.pdf](http://www.onsemi.com/site/pdf/Patent-Marking.pdf). SCILLC reserves the right to make changes without further notice to any products herein. SCILLC makes no warranty, representation or guarantee regarding the suitability of its products for any particular purpose, nor does SCILLC assume any liability arising out of the application or use of any product or circuit, and specifically disclaims any and all liability, including without limitation special, consequential or incidental damages. "Typical" parameters which may be provided in SCILLC data sheets and/or specifications can and do vary in different applications and actual performance may vary over time. All operating parameters, including "Typicals" must be validated for each customer application by customer's technical experts. SCILLC does not convey any license under its patent rights nor the rights of others. SCILLC products are not designed, intended, or authorized for use as components in systems intended for surgical implant into the body, or other applications intended to support or sustain life, or for any other application in which the failure of the SCILLC product could create a situation where personal injury or death may occur. Should Buyer purchase or use SCILLC products for any such unintended or unauthorized application, Buyer shall indemnify and hold SCILLC and its officers, employees, subsidiaries, affiliates, and distributors harmless against all claims, costs, damages, and expenses, and reasonable attorney fees arising out of, directly or indirectly, any claim of personal injury or death associated with such unintended or unauthorized use, even if such claim alleges that SCILLC was negligent regarding the design or manufacture of the part. SCILLC is an Equal Opportunity/Affirmative Action Employer. This literature is subject to all applicable copyright laws and is not for resale in any manner.

### PUBLICATION ORDERING INFORMATION

LITERATURE FULFILLMENT:  
Literature Distribution Center for ON Semiconductor  
P.O. Box 5163, Denver, Colorado 80217 USA  
Phone: 303-675-2175 or 800-344-3860 Toll Free USA/Canada  
Fax: 303-675-2176 or 800-344-3867 Toll Free USA/Canada  
Email: [orderlit@onsemi.com](mailto:orderlit@onsemi.com)

N. American Technical Support: 800-282-9855 Toll Free  
USA/Canada  
Europe, Middle East and Africa Technical Support:  
Phone: 421 33 790 2910  
Japan Customer Focus Center  
Phone: 81-3-5817-1050

ON Semiconductor Website: [www.onsemi.com](http://www.onsemi.com)  
Order Literature: <http://www.onsemi.com/orderlit>

For additional information, please contact your local Sales Representative